

VTPB SERIES

Vacuum Pump with Blowback

Technical Specifications

The VacTrac™ VTPB Series blowback vacuum pumps features non-reversing valves with Pulse Jet™ Blowback and is designed to convey dusty materials and some powders over long distances. The blowback cycle cleans the filter on demand and aids in emptying the vacuum receivers. With the help of unique air directional valves, the power unit automatically cycles from load cycle to blowback without stopping and reversing the motor and blower.

Available in 25-30 hp models.



Features

Standard Features

- Positive displacement blower
- 460/3/60 totally-enclosed fan-cooled (TEFC) motor
- Non-reversing valve design
- NEMA-12 junction box with starter mounted on unit
- Vacuum gauge
- Mechanical high vacuum relief valve
- High vacuum safety switch
- Premium discharge silencer

Optional Features

- Sound enclosure
- Fused disconnect (VTPB 25-30)
- NEMA 4 junction box
- 208/3/60, 230/3/60, 380/3/50, 415/3/50, 575/3/60 voltage
- Re-sheave power unit
- Retrofit junction box to convert old-style or other manufacturers' vacuum power units to use new VacTrac controllers. Specify HP and voltage when ordering

Product Diagrams

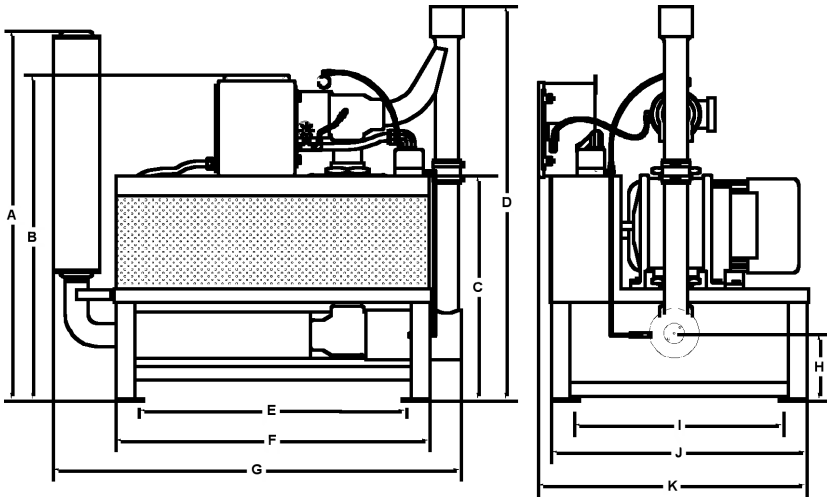

Model	A in. (cm)	B in. (cm)	C in. (cm)	D in. (cm)	E in. (cm)	F in. (cm)	G in. (cm)	H in. (cm)	I in. (cm)	J in. (cm)	K in. (cm)
VTPB25	80 (203)	60 (152)	39 (101)	74 (188)	42.5 (108)	46 (117)	65 (166)	9 (23)	31.5 (80)	35 (89)	32 (81)
VTPB30											

Specifications

Model	HP (kW)	Line Size OD in.	Air Flow cfm (cmh)	Amp Draw 230V	Amp Draw 460V	Amp Draw 575V	Shipping Weight lbs. (kg)
VTPB25	25 (18.7)	4" sch 10	570 (968)	49.6	24.8	19.8	1600 (726)
VTPB30	30 (22.4)	5" sch 10	711 (1208)	76.3	38.1	30.4	1800 (816)

Model	Recommended Vacuum Receivers cu. ft. (l)
VTP20	3.0, 6.0 (84.9, 169.9)
VTP30	6.0 (169.9)